

Startup Guide

Keysight M9187A PXI Digital IO Module



Notices

© Keysight Technologies, Inc. 2014

No part of this manual may be reproduced in any form or by any means (including electronic storage and retrieval or translation into a foreign language) without prior agreement and written consent from Keysight Technologies, Inc. as governed by United States and international copyright laws.

Manual Part Number

M9187-90001

Edition

Third Edition, December 2014
Published in U.S.A.
900 S. Taft Avenue,
Loveland, CO. 80537

Trademarks

PICMIG[®], COMPACT PCI[®], and Advanced TCA[®] are registered trademarks of the PCI Industrial Computer Manufacturers Group

PCI-SIG[®], PCI Express[®], and PCIe[®] are registered trademarks of PCI-SIG

Sales and Technical Support

To contact Keysight for sales and technical support, refer to the support links on the following Keysight websites:

www.keysight.com/find/M9187A (product-specific information and support, software and documentation updates)

www.keysight.com/find/assist (world-wide contact information for repair and service)

Declaration of Conformity

Declarations of Conformity for this product and for other Keysight products may be downloaded from the Web. Go to <http://www.keysight.com/go/conformity> and click on “Declarations of Conformity.” You can then search by product number to find the latest Declaration of Conformity.

Technology Licenses

The hardware and/or software described in this document are furnished under a license and may be used or copied only in accordance with the terms of such license.

Warranty

THE MATERIAL CONTAINED IN THIS DOCUMENT IS PROVIDED “AS IS,” AND IS SUBJECT TO BEING CHANGED, WITHOUT NOTICE, IN FUTURE EDITIONS. FURTHER, TO THE MAXIMUM EXTENT PERMITTED BY APPLICABLE LAW, KEYSIGHT DISCLAIMS ALL WARRANTIES, EITHER EXPRESS OR IMPLIED, WITH REGARD TO THIS MANUAL AND ANY INFORMATION CONTAINED HEREIN, INCLUDING BUT NOT LIMITED TO THE IMPLIED WARRANTIES OF MERCHANTABILITY AND FITNESS FOR A PARTICULAR PURPOSE. KEYSIGHT SHALL NOT BE LIABLE FOR ERRORS OR FOR INCIDENTAL OR CONSEQUENTIAL DAMAGES IN CONNECTION WITH THE FURNISHING, USE, OR PERFORMANCE OF THIS DOCUMENT OR OF ANY INFORMATION CONTAINED HEREIN. SHOULD KEYSIGHT AND THE USER HAVE A SEPARATE WRITTEN AGREEMENT WITH WARRANTY TERMS COVERING THE MATERIAL IN THIS DOCUMENT THAT CONFLICT WITH THESE TERMS, THE WARRANTY TERMS IN THE SEPARATE AGREEMENT SHALL CONTROL.

Keysight Technologies does not warrant third-party system-level (combination of chassis, controllers, modules, etc.) performance, safety, or regulatory compliance unless specifically stated.

DFARS/Restricted Rights Notices

If software is for use in the performance of a U.S. Government prime contract or subcontract, Software is delivered and licensed as “Commercial computer software” as defined in DFAR 252.227-7014 (June 1995), or as a “commercial item” as defined in FAR 2.101(a) or as “Restricted computer software” as defined in FAR 52.227-19 (June 1987) or any equivalent agency regulation or contract clause. Use, duplication or disclosure of Software is subject to Keysight Technologies’ standard commercial license terms, and non-DOD Departments and Agencies of the U.S. Government will receive no greater than Restricted Rights as defined in FAR 52.227-19(c)(1-2) (June 1987). U.S. Government users will receive no greater than Limited Rights as defined in FAR 52.227-14 (June 1987) or DFAR 252.227-7015 (b)(2) (November 1995), as applicable in any technical data.

Safety Information

The following general safety precautions must be observed during all phases of operation of this instrument. Failure to comply with these precautions or with specific warnings or operating instructions in the product manuals violates safety standards of design, manufacture, and intended use of the instrument. Keysight Technologies assumes no liability for the customer's failure to comply with these requirements.

General

Do not use this product in any manner not specified by the manufacturer. The protective features of this product must not be impaired if it is used in a manner specified in the operation instructions.

Before Applying Power

Verify that all safety precautions are taken. Make all connections to the unit before applying power. Note the external markings described under "Safety Symbols".

Ground the Instrument

Keysight chassis' are provided with a grounding-type power plug. The instrument chassis and cover must be connected to an electrical ground to minimize shock hazard. The ground pin must be firmly connected to an electrical ground (safety ground) terminal at the power outlet. Any interruption of the protective (grounding) conductor or disconnection of the protective earth terminal will cause a potential shock hazard that could result in personal injury.

Do Not Operate in an Explosive Atmosphere

Do not operate the module/chassis in the presence of flammable gases or fumes.

Do Not Operate Near Flammable Liquids

Do not operate the module/chassis in the presence of flammable liquids or near containers of such liquids.

Cleaning

Clean the outside of the Keysight module/chassis with a soft, lint-free, slightly dampened cloth. Do not use detergent or chemical solvents.

Do Not Remove Instrument Cover

Only qualified, service-trained personnel who are aware of the hazards involved should remove instrument covers. Always disconnect the power cable and any external circuits before removing the instrument cover.

Keep away from live circuits

Operating personnel must not remove equipment covers or shields. Procedures involving the removal of covers and shields are for use by service-trained personnel only. Under certain conditions, dangerous voltages may exist even with the equipment switched off. To avoid dangerous electrical shock, DO NOT perform procedures involving cover or shield removal unless you are qualified to do so.

DO NOT operate damaged equipment

Whenever it is possible that the safety protection features built into this product have been impaired, either through physical damage, excessive moisture, or any other reason, REMOVE POWER and do not use the product until safe operation can be verified by service-trained personnel. If necessary, return the product to an Keysight Technologies Sales and Service Office for service and repair to ensure the safety features are maintained.

DO NOT block the primary disconnect

The primary disconnect device is the appliance connector/power cord when a chassis used by itself, but when installed into a rack or system the disconnect may be impaired and must be considered part of the installation.

Do Not Modify the Instrument

Do not install substitute parts or perform any unauthorized modification to the product. Return the product to an Keysight Sales and Service Office to ensure that safety features are maintained.

In Case of Damage

Instruments that appear damaged or defective should be made inoperative and secured against unintended operation until they can be repaired by qualified service personnel

CAUTION

Do NOT block vents and fan exhaust: To ensure adequate cooling and ventilation, leave a gap of at least 50mm (2") around vent holes on both sides of the chassis.

Do NOT operate with empty slots: To ensure proper cooling and avoid damaging equipment, fill each empty slot with an AXle filler panel module.

Do NOT stack free-standing chassis: Stacked chassis should be rack-mounted.

All modules are grounded through the chassis: During installation, tighten each module's retaining screws to secure the module to the chassis and to make the ground connection.

WARNING

Operator is responsible to maintain safe operating conditions. To ensure safe operating conditions, modules should not be operated beyond the full temperature range specified in the Environmental and physical specification. Exceeding safe operating conditions can result in shorter lifespan, improper module performance and user safety issues. When the modules are in use and operation within the specified full temperature range is not maintained, module surface temperatures may exceed safe handling conditions which can cause discomfort or burns if touched. In the event of a module exceeding the full temperature range, always allow the module to cool before touching or removing modules from the chassis.

Safety Symbols







CAUTION

A CAUTION denotes a hazard. It calls attention to an operating procedure or practice, that, if not correctly performed or adhered to could result in damage to the product or loss of important data. Do not proceed beyond a CAUTION notice until the indicated conditions are fully understood and met.

WARNING

A WARNING denotes a hazard. It calls attention to an operating procedure or practice, that, if not correctly performed or adhered to, could result in personal injury or death. Do not proceed beyond a WARNING notice until the indicated conditions are fully understood and met.

Products display the following symbols:

-  Warning, risk of electric shock
-  Refer to manual for additional safety information.
-  Earth Ground.
-  Chassis Ground.
-  Alternating Current (AC).
-  Standby Power. Unit is not completely disconnected from AC mains when switch is in standby.
-  Antistatic precautions should be taken.

For localized Safety Warnings, Refer to Keysight Safety document (p/n 9320-6792).



The instrument has been tested, investigated and found to comply with the requirements of the Standard(s) for Electrical Measuring & Test Equipment.



Notice for European Community: This product complies with the relevant European legal Directives: EMC Directive (2004/108/EC) and Low Voltage Directive (2006/95/EC).



This is the symbol for an Industrial, Scientific, and Medical Group 1 Class A product.



The Regulatory Compliance Mark (RCM) mark is a registered trademark. This signifies compliance with the Australia EMC Framework regulations under the terms of the Radio Communication Act of 1992.

ICES/NMB-001

ICES/NMB-001 indicates that this ISM device complies with the Canadian ICES-001.



This symbol represents the time period during which no hazardous or toxic substance elements are expected to leak or deteriorate during normal use. Forty years is the expected useful life of this product.



Waste Electrical and Electronic Equipment (WEEE) Directive 2002/96/EC

This product complies with the WEEE Directive (2002/96/EC) marking requirement. The affixed product label (see below) indicates that you must not discard this electrical/electronic product in domestic household waste.

Product Category: With reference to the equipment types in the WEEE directive Annex 1, this product is classified as a "Monitoring and Control instrumentation" product.

Do not dispose in domestic household waste.

To return unwanted products, contact your local Keysight office, or see www.keysight.com/environment/product for more information.



Contents

Keysight PXI Digital IO Module Introduction	9
Related documentation	9
Step 1: Unpack and Inspect the Module	10
ESD	10
Inspect for damage.	11
Return the module for service	11
Step 2: Verify Shipment Contents.	12
Step 3: Install the Software on the Host Computer	12
System requirements	13
PXI System.	13
Power the controller.	14
Install Keysight IO Libraries Suite	14
Install instrument drivers	15
Step 4. Connect the Controller to the PXI Chassis.	16
Using a remote PC	16
Using an embedded computer.	16
Step 5: Install the Module in the PXI Chassis.	17
Step 6. Verify Operation of the Module	19
Run Keysight IO Libraries Connection Expert	19
Verify operation	20
Characteristics	21
Module Functional Description.	21
Module Programming.	22
Module Front Panel, Connector and Pin Out.	23
M9187A Module Accessories	25
Y1181A 78 Pin Shielded Connector Block.	26
Y1187A, Y1188A 78 Pin Male to Female Connector Cable.	27
Disassembling the Connector Block Clam Shells	28
Electrical Operating Conditions	29
Transients	29
High Energy Sources	29
Electrical Operating Conditions	29

Keysight PXI Digital IO Module Introduction

The Keysight M9187A PXI Digital IO Module provides 32 high output voltage and current channels along with 32 dual variable threshold input channels.

- Each of the output channels can drive the output either high (sourcing up to 0.4A) or low (sinking up to 0.5A), or three-stated (off). All output channels are protected against over-voltage, over-current, and thermal overload. An external power supply is required for high-side driving.
- The 32 input channels are read by comparing the input DC voltage to two threshold voltages that can be set between 0.3 and 50Vdc. The thresholds can programmatically be set with 12.5mVdc resolution, permitting input testing against the system thresholds that define a logic low or logic high. Note that the two thresholds are the same for all 32 input channels -- the thresholds are not independently set for each input channels.

WARNING

Inputs to the Keysight M9187A module are DC voltage only.

- The inputs can be connected directly to the outputs without risk of damage, allowing module configuration for operation as 32 channels of independent input and output or as 32 channels of configurable I/O.
- User connection is a 78 pin D-type connector on the module front panel.

Keysight also supplies software drivers allowing you to support the module in all popular PXI chassis' and programming environments. Soft Front Panel software allows you to exercise the channels for test purposes.

For detailed usage instructions, refer to the M9187A Digital Soft Front Panel help file on the Digital IO Module Software and Product Information CD.

Related documentation

This Startup Guide, and the documentation listed below, are on the Digital IO Module Software and Product Information CD.

- Help file for the Digital IO Module Soft Front Panel
- Help file for the Digital IO Module IVI-C/IVI-COM device drivers
- Help file for the Digital IO Module LabVIEW G device drivers
- Keysight PXI Digital IO Module Specifications. For the latest specifications, check the Keysight web site at: www.keysight.com/find/pxi-dio.

Step 1: Unpack and Inspect the Module

CAUTION

Keysight's PXI Modules are shipped in materials that prevent static electricity damage. The modules should only be removed from the packaging in an anti-static area ensuring that correct anti-static precautions are taken. Store all modules in anti-static envelopes when not in use.

ESD

Electrostatic discharge (ESD) can damage or destroy electronic components. All work on electronic assemblies should be performed at a static-safe work station. The following figure shows an example of a static-safe work station using two types of ESD protection.

- Conductive table-mat and wrist-strap combination.
- Conductive floor-mat and heel-strap combination.

Both types, when used together, provide a significant level of ESD protection. Of the two, only the table-mat and wrist-strap combination provides adequate ESD protection when used alone. To ensure user safety, the static-safe accessories must provide at least $1\text{ M}\Omega$ of isolation from ground. Purchase acceptable ESD accessories from your local supplier.

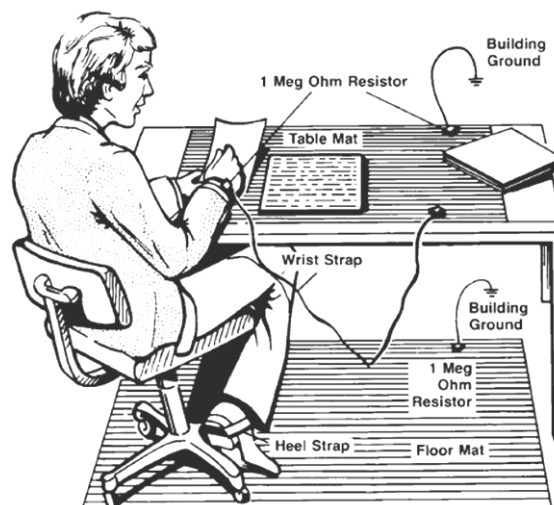

Inspect for damage

After unpacking the module, carefully inspect it for any shipping damage. Report any damage to the shipping agent immediately, as such damage is not covered by the warranty.

CAUTION

To avoid damage when handling a module; do not touch exposed connector pins.

Return the module for service

Should it become necessary to return a Keysight module for repair or service, follow the steps below:

- 1 Review the warranty information shipped with your product.
- 2 Contact Keysight to obtain a return authorization and return address. If you need assistance finding Keysight contact information go to www.keysight.com/find/assist (worldwide contact information for repair and service) or refer to the **Support** information on the product web page at: www.keysight.com/find/pxi-dio.
- 3 Write the following information on a tag and attach it to the malfunctioning equipment.
 - Name and address of owner. A Post Office box is not acceptable as a return address.
 - Product model number (M9187A).
 - Product serial number (for example, MYXXXXXXXX). The serial number label is located on the side of the module.
 - A description of failure or service required.
- 4 Carefully pack the module in its original ESD bag and carton. If the original carton is not available, use bubble wrap or packing peanuts, place the instrument in a sealed container and mark the container "FRAGILE".
- 5 On the shipping label, write ATTENTION REPAIR DEPARTMENT and the service order number (if known).

NOTE

If any correspondence is required, refer to the product by serial number and model number.

Step 2: Verify Shipment Contents

Your shipment should have included the following:

- The Keysight PXI M9187A Digital IO module that you ordered.
- This document (Keysight PXI M9187A Module Startup Guide).
- A *Digital IO Module Software and Product Information* CD. This CD contains software, drivers and all product printed documentation in PDF format for the PXI Digital IO Module.
- An *Automation-Ready CD with Keysight IO Libraries Suite* (version 16.0 or later).
- Any other accessories that you ordered (cables, connectors, etc.).

Step 3: Install the Software on the Host Computer

The following illustration shows typical system installations.

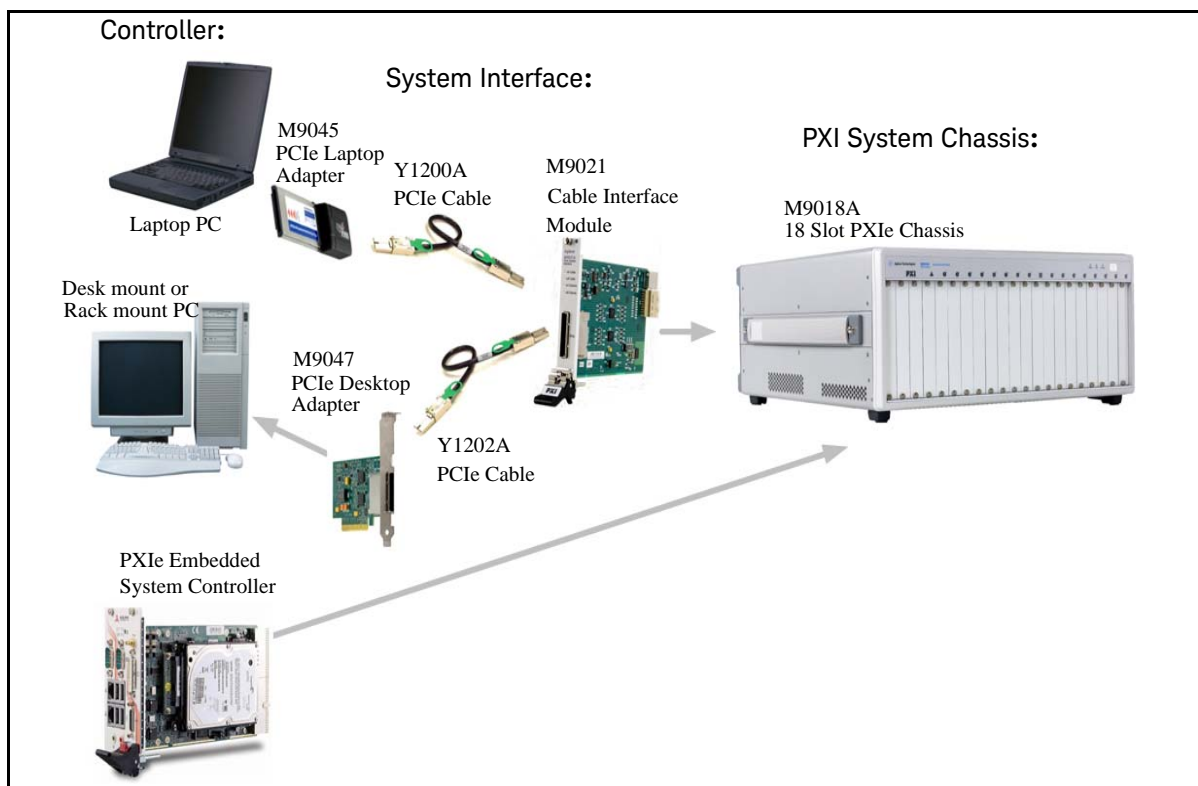

NOTE

Do not install the PXI modules in the PXI chassis yet! You must install the software prior to installing the modules in the chassis so that Keysight IO Libraries Connection Expert finds them.

System requirements

The following table lists the minimum system requirements for Keysight IO Libraries Suite 16. In general, any x86 or x64 (except Itanium) should work but there may be a significant decrease in performance.

Operating System	Windows XP Service Pack 3 or later	Windows Vista SP1 and SP2 (32-bit and 64-bit), Business, Ultimate, Enterprise, Home Basic, and Home Premium	Windows 7 (32- and 64-bit) Starter, Home Basic, Home Premium, Professional, Ultimate, Enterprise
Processor Speed	600 MHz or higher required, 800 MHz recommended	1Ghz 32-bit (x86), 1GHz 64-bit (x64), no support for Itanium64	1Ghz 32-bit (x86), 1GHz 64-bit (x64), no support for Itanium64
	256 MB minimum (1 GB or greater recommended)	1 GB minimum	1 GB minimum
	1.5 GB available hard disk space, includes: <ul style="list-style-type: none"> • 1GB available for Microsoft .NET Framework 3.5 SP1[†] • 100MB for Keysight IO Libraries Suite 	1.5 GB available hard disk space, includes: <ul style="list-style-type: none"> • 1GB available for Microsoft .NET Framework 3.5 SP1² • 100MB for Keysight IO Libraries Suite 	1.5 GB available hard disk space, includes: <ul style="list-style-type: none"> • 1GB available for Microsoft .NET Framework 3.5 SP1² • 100MB for Keysight IO Libraries Suite
	Super VGA (800x600) 256 colors or more	Support for DirectX 9 graphics with 128MB graphics memory recommended (Super VGA graphics is supported)	Support for DirectX 9 graphics with 128MB graphics memory recommended (Super VGA graphics is supported)
	Microsoft Internet Explorer 6.0 or greater	Microsoft Internet Explorer 7 or greater	Microsoft Internet Explorer 7 or greater

* Because of the installation procedure, less memory may be required for operation than is required for installation.

† .NET Framework Runtime Components are installed by default with Windows Vista. Therefore you may not need this amount of available disk space.

PXI System

PXI system/ host controller	A PXI or PXI Express embedded controller or PC host controller is required.
-----------------------------	---

Power the controller

- If you are using a desktop, laptop, or rack mount PC as remote controller:
 - 1 Install any peripheral devices in the PC (e.g., PCIe Interface adapters, etc.). Follow the manufacturers instructions.
 - 2 Power up the controller. Do not apply power to the PXI chassis yet.
 - 3 Choose the default option for any “Found Hardware” dialogs.
- If you are using a PXI embedded computer as the host computer:
 - 1 Install the embedded computer module into the PXI chassis following the manufacturers instructions.
 - 2 Connect peripherals such as a mouse, keyboard, monitor, CD drive, etc.
 - 3 Power up the chassis.
 - 4 Choose the default option for any “Found Hardware” dialogs

Install Keysight IO Libraries Suite

Keysight IO Libraries Suite 16.0 (or later) is required for the PXI modules. It includes the Keysight Connection Expert, the IVI Shared Components, and the VISA Shared Components.

NOTE

Keysight IO Libraries version 16.0 (or later) **must** be installed prior to installing and running any other software and prior to powering the chassis. The latest version can be downloaded from: www.keysight.com/find/iosuite.

- 1 Insert the *Automation-Ready CD with Keysight IO Libraries Suite* into the CD-ROM drive of your system controller. Wait a few seconds for the auto-run window to appear. If the auto-run window does not appear automatically:
 - Click **Start > Run...**
 - Type: `<drive>:Autorun\IOLibraries.hta` where `<drive>` is your CD drive letter.
- 2 Follow the installation instructions that came with the IO Libraries Suite.

NOTE

If the **IVI Shared Components** and **VISA Shared Components** are not already installed on your PC, Keysight IO Libraries Suite installs them in the default locations. If they are already installed, the installer upgrades them to the latest version, using the same location used by the older version. If this is a first-time installation, you can select installation locations for these components by choosing a Custom Installation.

Install instrument drivers

- 1 Insert the *Digital IO Module Software and Product Information* CD into the CD-ROM drive of your PC.

Wait a few seconds for the auto-run window to appear. If the auto-run window does not appear automatically:

- Click Start > Run...
 - Type: <drive>:Autorun.exe where <drive> is your CD drive letter.
- 2 Select the **Install** Software link. Follow the installer prompts. Accept all of the default directories specified during installation if prompted.
 - 3 After the Welcome screen, you will be prompted three times for license agreements. The software installer installs the following drivers:
 - Keysight Modular Software License Agreement. The installer program installs the Soft Front Panel (SFP) application and other object code to connect to the module. Accept the license terms and click Next.
 - Keysight IVI Driver Source Code License Agreement. The Interchangeable Virtual Instrument (IVI) driver is available for programming the Keysight modules using Microsoft development environments (e.g., Visual Studio, C, C++, C#, Visual Basic), Keysight VEE, MATLAB, or National Instruments Labview. Accept the license terms and click Next.
 - Keysight Software License Agreement for drivers for use with LabVIEW Software. The LABVIEW driver provides access to the functionality of the module through LabVIEW VIs. This driver works in National Instruments LabVIEW development environments. Before this driver can be installed, your computer must already have the IVI Shared Components installed. Accept the license terms and click Next.

NOTE

Installing Keysight IO Libraries also installs the IVI Shared Components. The IVI Shared Components are required before IVI drivers (e.g., IVI-COM, IVI-C) can be installed from the product reference CD.

- 4 Next, the installer indicates the LabVIEW installations found on your host computer. Click Next
- 5 After accepting the licenses, the driver software is ready to be installed on your host computer. Click Install.
- 6 When the installation wizard is finished, you will be prompted to reboot your host computer. Do not reboot the host computer at this time! Select **“No, I will restart my computer later.”** Power down the host computer. Proceed to **“Step 4. Connect the Controller to the PXI Chassis”** on the next page.

Step 4. Connect the Controller to the PXI Chassis

NOTE

To ensure proper system operation and the PC's ability to enumerate all of the PXI modules, you must use an approved embedded PC, desktop PC, or laptop PC along with approved PCIe adaptor and cable.

Using a remote PC

Refer to the following figure. Make certain that both the PC and the PXI chassis are turned off. Unplug the chassis from the ac power mains. If you are using the M9018A 18 Slot PXIe chassis, install the Keysight M9021A PCIe Cable Interface module in the chassis.

- If you are using a desktop or rack mount PC, install the M9047A PCIe Desktop Adapter in the PC. With a Keysight Y1202A cable, connect the adapter to the System Interface module.
- If you are using a laptop PC, install the M9045A PCIe ExpressCard Adapter in the laptop. With a Keysight Y1200A cable, connect the adapter to the System Interface module on the PXI chassis.

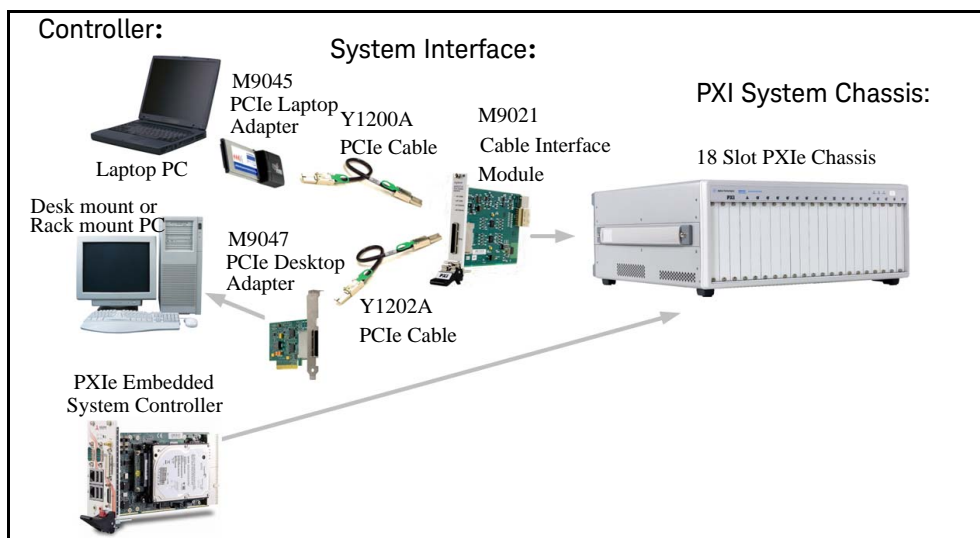

Using an embedded computer

Refer to the figure above. If you are using an embedded controller in the PXI chassis, you should have installed it prior to installing the Keysight IO Libraries and instrument drivers. No cables or other adapters are required. After installation, proceed to **“Step 5: Install the Module in the PXI Chassis”**

Step 5: Install the Module in the PXI Chassis

WARNING

- **PXI hardware does not support “hot-swap” capabilities (changing modules while power is applied to the chassis).**
- **Before installing Keysight PXI Modules into the chassis, the chassis must be powered off to prevent damage to the PXI module. Remove all cables/terminal blocks from the module prior to installing or removing the module.**

NOTE

The module can be used in a chassis with a cPCI, PXI-1, or PXIh chassis peripheral slot.

3

The module can be installed in any standard PXI slot marked with a peripheral slot compatibility image (a circle containing the slot number).

7^H

The module can also be installed in any hybrid PXI slot marked with a peripheral slot compatibility image (the letter “H” and a solid circle containing the slot number).

- 1 Make sure the PXI chassis power is turned off.
- 2 If the chassis has multiple fan speed settings, ensure that the fans are set to automatic. Do not set the fan speed to low or turn them off.
- 3 Position the chassis so that there is ample space between the chassis fan intake and exhaust vents. Blockage by walls or obstructions affects the air flow needed for cooling. (Refer to the chassis documentation for more information about cooling).
- 4 The modules are shipped with thread protectors over the mounting screws. These must be removed before installing the modules in a chassis.
- 5 Holding the PXI module by the injector/ejector handle, slide it into an available PXI (or hybrid) slot, as shown in the following figure.
 - Install the module in the PXI slot by placing the module card edges into the front module guides (top and bottom).
 - Slide the module to the rear of the chassis and assure that the injector/ejector handle is pushed down in the unlatched (downward) position.
 - Slide the module completely into the chassis. When you begin to feel resistance, push up on the injector/ejector handle to fully seat the module into the chassis.

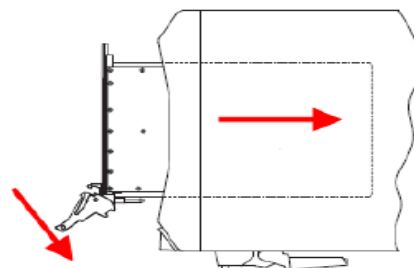

- 6 Latch the module by pulling up on the injector/ejector handle and secure the front panel to the chassis using the module mounting screws.
- 7 Tighten the screws on the module (or remote controller) front panel. Performance may suffer if the screws are not securely tightened.
- 8 Install all chassis covers, filler panels, and air inlet modules after installing the module. Missing filler panels may disrupt necessary air circulation in the chassis.
- 9 If you are using a remote controller, connect the System Interface Card in the chassis to the host computer.
- 10 Plug in and power up the PXI chassis. Verify that the chassis fans are operating and free of obstructions that may restrict airflow.

CAUTION

If you are using a remote controller linked to the M9021A Cable Interface, you must power up the chassis **BEFORE** you power up the PC. When you power down your system, you must Shut Down the PC **BEFORE** you power down the chassis.

NOTE

If you are using MXI-3 to connect a desktop PC to a PXI chassis or link to multiple chassis, power up the system as follows:

- For a system with a PC and one chassis, power up the chassis before powering the PC.
 - For a system with more than one chassis, power on the last chassis in the system followed by the penultimate, etc. Finally, turn on the PC or chassis containing the system controller.
-

- 11 If you are using a remote host computer (rack mount, desktop, or laptop PC), power-on the computer. Choose the default option for any “Found New Hardware” dialogs.

NOTE

After all of the “Found New Hardware” dialogs are complete, you must reboot the host computer.

Chassis Power Down Process

CAUTION

If you are using a remote controller linked to the M9021A Cable Interface, you must Shut Down the PC **BEFORE** you power down the chassis. When you restore power, you must power up the chassis **BEFORE** you power up the PC.

Step 6. Verify Operation of the Module

Run Keysight IO Libraries Connection Expert

If Keysight Connection Expert is already running on the system controller, click the **Refresh All** button to identify any hardware you have just installed or re-connected.

If Connection Expert is not already running, run it now to verify your I/O configuration. In the Windows Notification Area, click the IO icon (), then click Keysight Connection Expert.

Locate your interfaces and instruments in the Keysight Connection Expert Explorer Pane. The following graphic shows the Connection Expert screen.

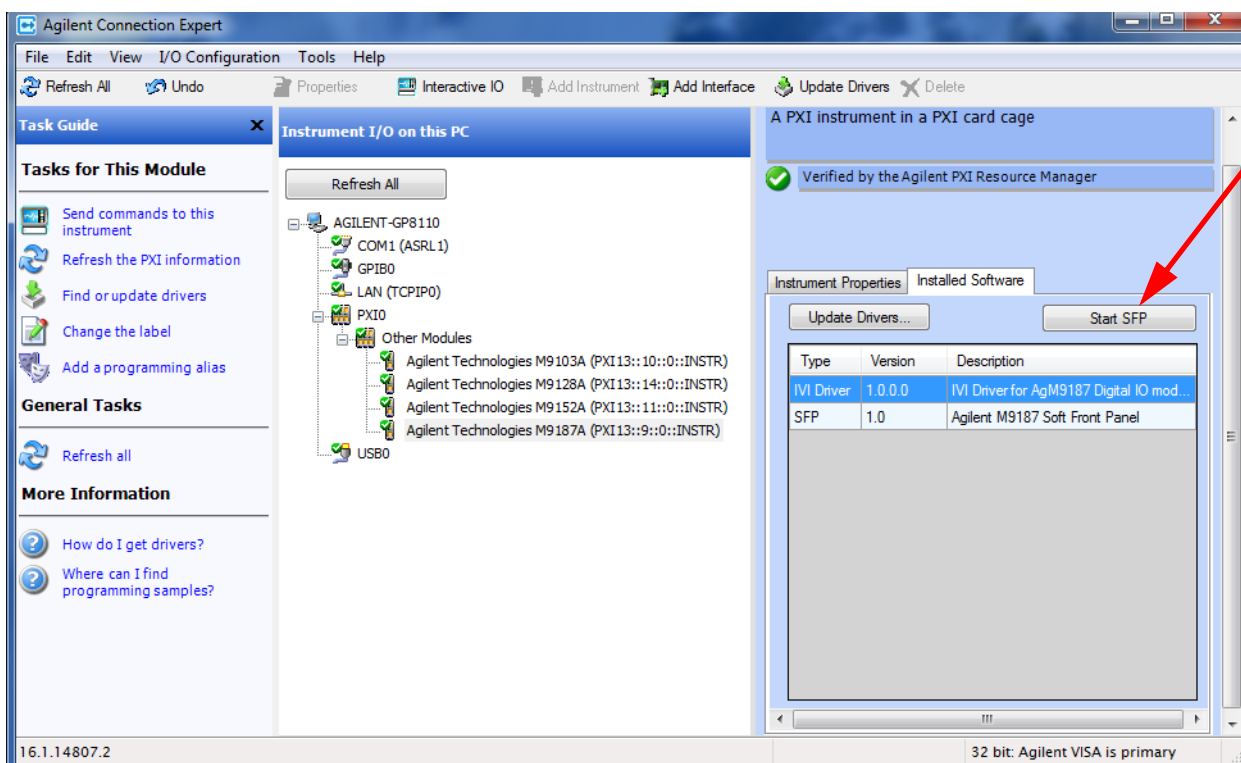

Select the module in the center pane (Instrument I/O on this PC). The right-hand Pane shows the instrument properties. Select the **Installed Drivers** tab then click the **Start SFP** button. You can use the M9187A Soft Front Panel (SFP) software to set the outputs read the inputs, and verify operation of the module. The Soft Front Panel software was installed as part of the Software installation process.

For detailed instructions for using the M9187A Digital IO module, refer to the Soft Front Panel help file on the Digital IO Module Software and Product Information CD.

Refer to the SFP help file on the *Digital IO Module Software and Product Information CD* for specific detailed information on the SFP. The following graphic shows an example of the SFP for the M9187A PXI Digital IO module.

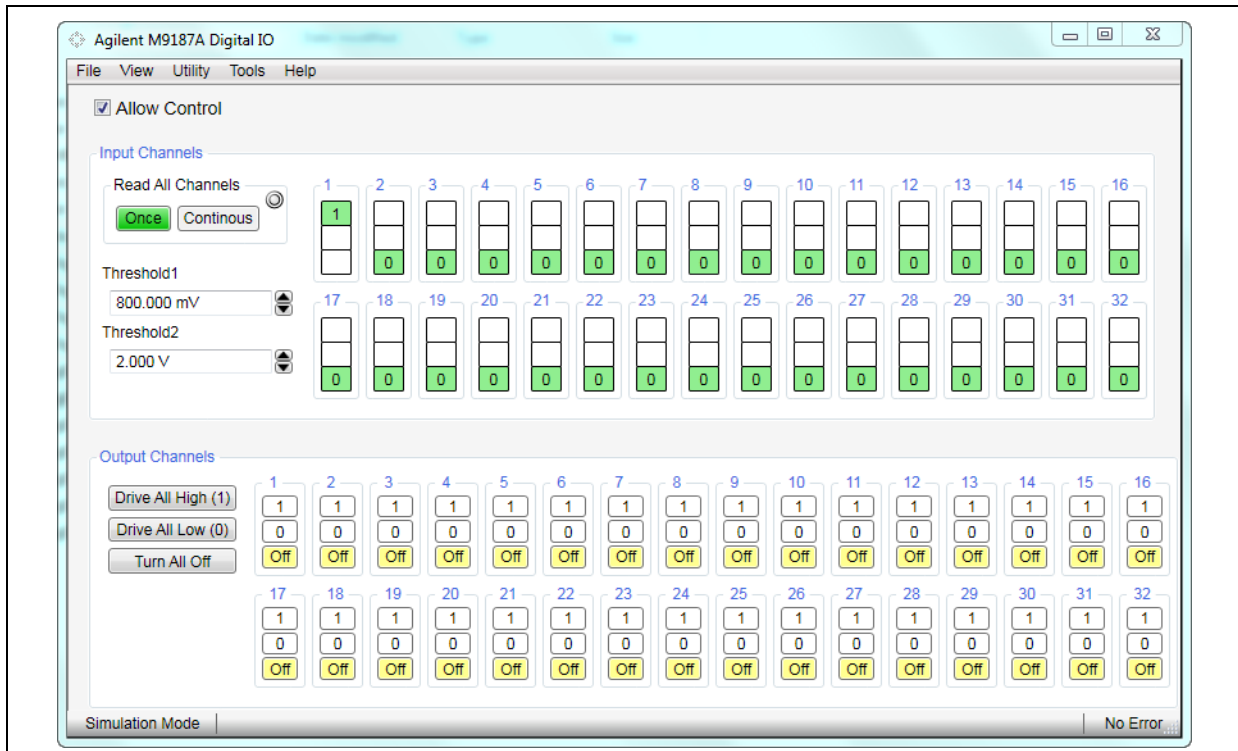

If you have another application, either your own program or another instance of the SFP interface, that has initialized the M9187A module, then the SFP enters its “monitor” mode. In this mode, you must check the “**Allow Control**” check box (upper left corner) before you can actually set the digital output channels. If **Allow Control** is not checked, the Output Channels section of the SFP display is grayed out.

Selecting the **Continuous** button allows the SFP monitor mode to continuously read and update the state of the digital inputs regardless of whether the **Allow Control** check box is checked or not. The “light” next to the **Continuous** button flashes to indicate the SFP is reading and updating the display.

Verify operation

There are no specific operational verification or self test procedures. However, you can use the Soft Front Panel software to set the outputs and read the inputs. Module specifications are guaranteed by design.

Characteristics

For detailed specifications, refer to the module Data Sheet on the *Digital IO Module Software and Product Information CD* or the module data sheet online at www.keysight.com/find/pxi-dio.

Module Functional Description

The Keysight PXI M9187A Digital IO module conforms to the single slot, 3U form factor (100mm by 160mm / 3.94 in. by 6.3 in.) Eurocard standard. These modules meet PXI Specification 2.2. Local bus, trigger bus, and star trigger are not included. The modules also include:

- CPCI Ejector Handle
- Front panel 78 pin D type connector
- The front panel secures to the chassis by two M2.5 x 6mm pan-head Posi-drive screws.

Figure 1 shows a functional block diagram for the module. The PCI connector provides +5Vdc, ±12Vdc, ground, as well as the control signals from the chassis backplane.

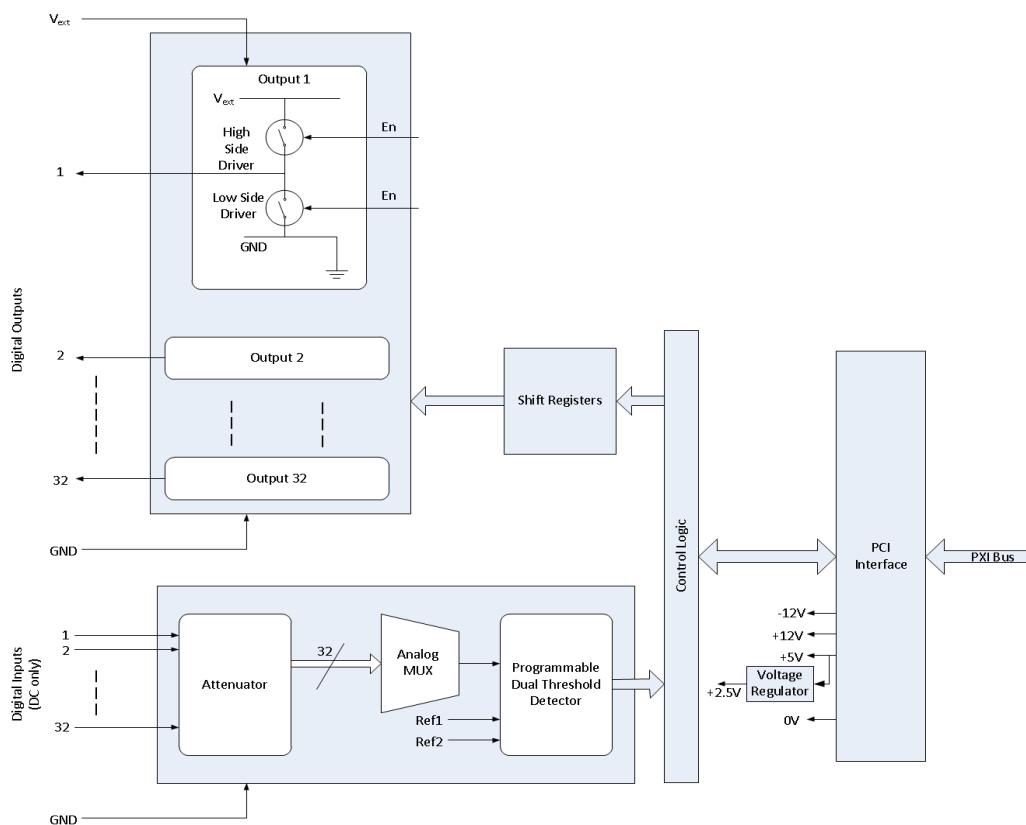

Figure 1 M9187A Digital IO Functional Block Diagram

The module's 32 channel output section comprises High Side and Low Side drivers and Shift Registers. The shift registers control the output drivers and are supplied with serial data from the PCI Bridge via the control logic. Each output can be switched to either sink current to the GND terminal via a Low Side driver device, or source current from the V_{ext} terminal via a High Side driver device. The outputs can also be tri-stated (off).

For serial input, the module's 32 input channels are attenuated, then multiplexed through an analog multiplexer. A programmable threshold detector circuit converts the analog signal into a digital data stream determined by the programmable high and low thresholds. The input data is then read by the PCI Bridge via the control logic.

Module Programming

Refer to the Soft Front Panel Help file for detailed operation of the module. For programming information, refer to the IVI C and LabVIEW driver help files. These help files are located on the *Digital IO Module Software and Product Information* CD

Module Front Panel, Connector and Pin Out

Figure 2 below shows the M9187A module front panel. [Figure 3](#) on page 24 shows the M9187A front panel connector (as viewed from the module front panel) and connector pinout. Table 1 on page 25 lists the front panel pin out connections by signal (channel number).

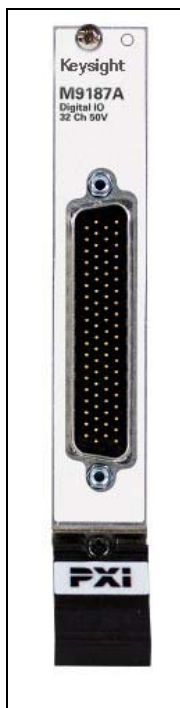

Figure 2 M9187A Front Panel

Figure 3 shows the M9187A front panel connector (as viewed from the module front panel) and the connector pinout. Table 1 on page 25 lists the connector by signal (channel) number.

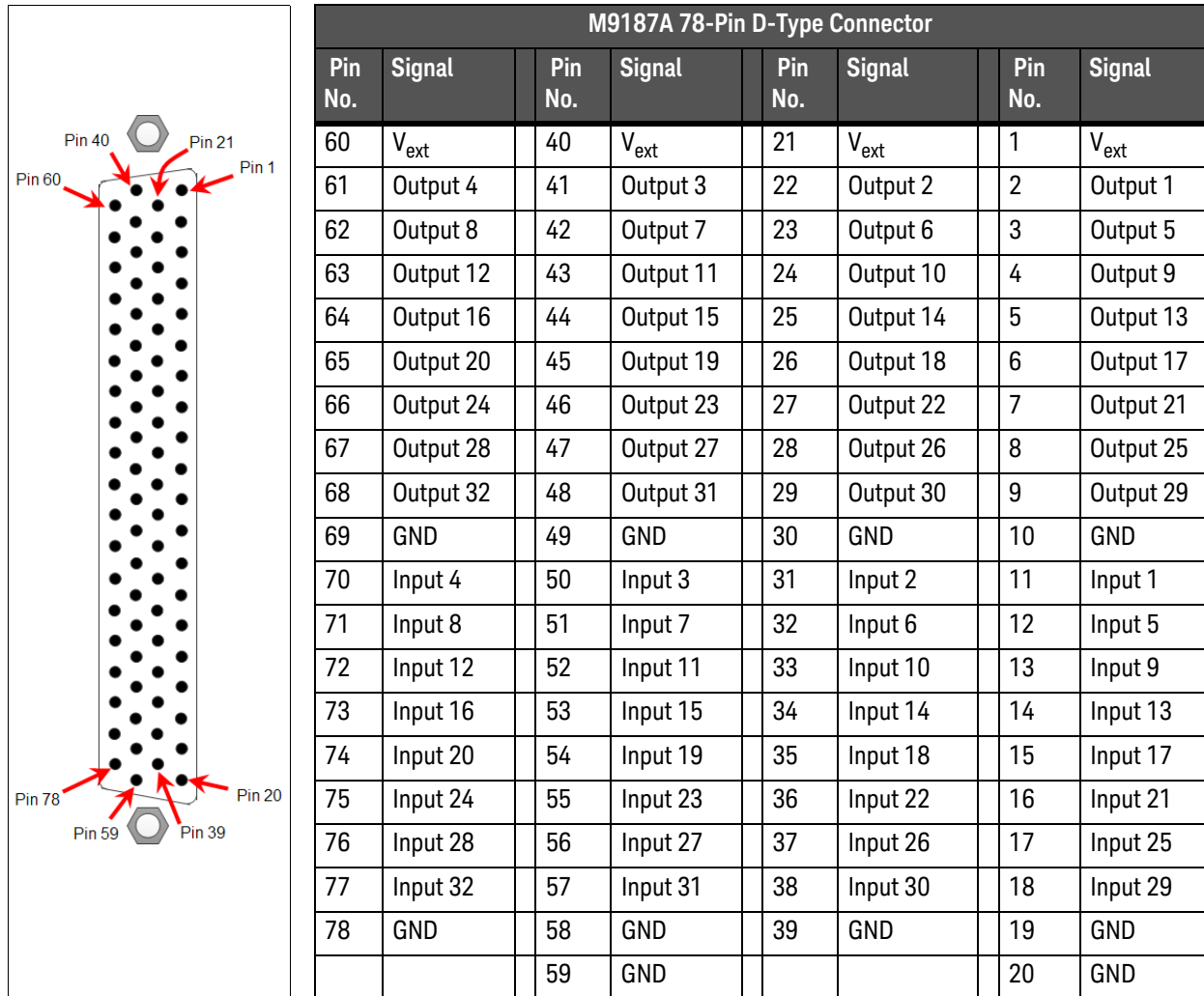

Figure 3 M9187A Front Panel Connector and Pinout

Signal	Pin No.						
V _{ext}	1, 21, 40, 60						
Gnd	10, 30, 49, 69, 19, 20, 39, 58, 59, 78						
Signal	Pin No.	Signal	Pin No.	Signal.	Pin No.	Signal.	Pin No.
Input 1	11	Input 2	31	Input 3	50	Input 4	70
Input 5	12	Input 6	32	Input 7	51	Input 8	71
Input 9	13	Input 10	33	Input 11	52	Input 12	72
Input 13	14	Input 14	34	Input 15	53	Input 16	73
Input 17	15	Input 18	35	Input 19	54	Input 20	74
Input 21	16	Input 22	36	Input 23	55	Input 24	75
Input 25	17	Input 26	37	Input 27	56	Input 28	76
Input 29	18	Input 30	38	Input 31	57	Input 32	77
Output 1	2	Output 2	22	Output 3	41	Output 4	61
Output 5	3	Output 6	23	Output 7	42	Output 8	62
Output 9	4	Output 10	24	Output 11	43	Output 12	63
Output 13	5	Output 14	25	Output 15	44	Output 16	64
Output 17	6	Output 18	26	Output 19	45	Output 20	65
Output 21	7	Output 22	27	Output 23	46	Output 24	66
Output 25	8	Output 26	28	Output 27	47	Output 28	67
Output 29	9	Output 30	29	Output 31	48	Output 32	68

Table 1 M9187A Signal (Channel) Number to Connector Pin Out

M9187A Module Accessories

Model	Description
Y1181A	PXI Connector Block: 78 pin, shielded, female D Sub
Y1187A	PXI Connector Cable: 78 pin, male to female, 1Meter
Y1188A	PXI Connector Cable: 78 Pin, male to female, 2Meter

Y1181A 78 Pin Shielded Connector Block

This shielded connector block provides a simple method of connecting wires to Keysight M9187A PXI Digital IO module with a 78 pin D-Type front panel connector. The connector block has a simple bar clamp for strain relief. The screw terminals accept wires up to 20AWG; the recommended torque for the screw terminals is 0.12 - 0.15 Nm. The following diagram shows the pinout of the connector block. The pin numbers match the pin numbers on the module's front panel connector. Refer to [“Disassembling the Connector Block Clam Shells”](#) on page 28 for disassembly instructions.

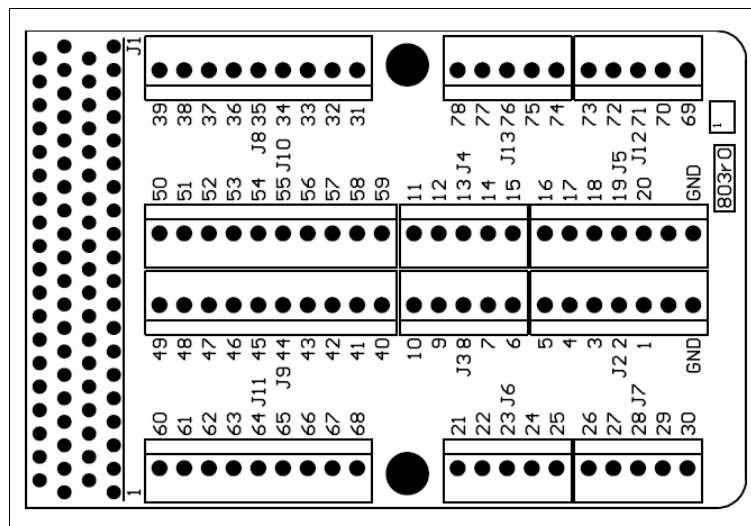

Figure 4 Y1181A 78 Pin Terminal Block Wiring Diagram

WARNING

Voltages greater than 60 Vdc present an electric shock hazard. Disconnect all source voltages before connecting or removing the source-to-modules I/O connector or wiring the connector block. All field wiring must be rated for the highest voltage applied to any single channel.

Y1187A, Y1188A 78 Pin Male to Female Connector Cable

These cable assemblies are used to extend the front panel connections of the M9187A PXI Digital IO module. The cable is PFA copper/tin, 26AWG with a 3A current rating. Nominal resistance is 0.2 Ω /M. The Y1187A is 1m long and the Y1188A is 2m long.



Figure 5 Y1187A, Y1188A 78 Pin Male to Female Connector Cable

WARNING

Voltages greater than 60 Vdc present an electric shock hazard. Disconnect all source voltages before connecting or removing the source-to-modules I/O connector or wiring the connector block. All field wiring must be rated for the highest voltage applied to any single channel.

Disassembling the Connector Block Clam Shells

- 1 Loosen the two screws indicated in Figure 6. These screws are captive to the bottom half of the clam shell. Note: the other two screws are for the strain relief.

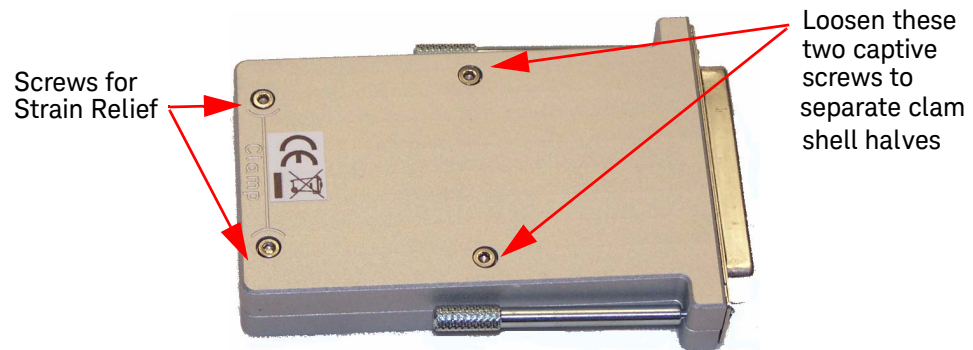

Figure 6 Disassembling the Terminal Block Clam Shell

- 2 Separate the two clam shell halves. Be careful not to lose the long screw locks used to secure the terminal block to the module.
- 3 To use the strain relief, loosen the two strain relief screws and lift up on the strain relief bar. Refer to Figure 7.

Wires go under strain relief bar. Do not over tighten strain relief clamp.

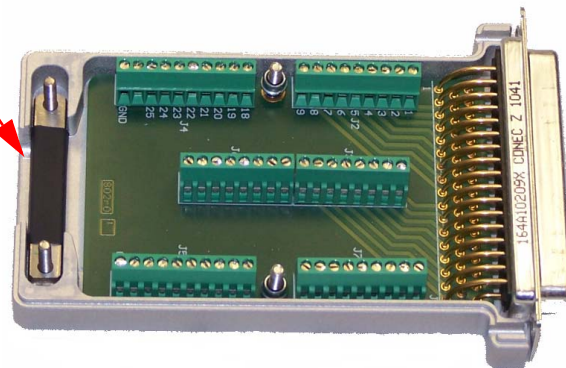

Figure 7 Using the Strain Relief Clamp

- 4 Insert your cable under the strain relief bar and retighten the two strain relief screws.

CAUTION

Do not over tighten the strain relief screws. Possible damage to the cable(s) may occur if overtightened. Use only sufficient tension to secure the cable in place.

- 5 To reassemble the clamshell, make certain the screw locks are in place. Place the clam shell halves together. Tighten the two clam shell screws.

Electrical Operating Conditions

WARNING

To avoid electric shock, turn off the chassis and disconnect or de-energize all field wiring to the modules before installing or removing any module or chassis slot cover.

Transients

The Digital IO module described in this manual is intended for low voltage applications only and should not be connected to circuits that may generate or conduct large transient voltages.

WARNING

Not for connection to mains. Do not connect any of the module's I/O pins directly to a mains power outlet.

High Energy Sources

These modules are designed to handle inputs up to their rated currents or their rated powers, whichever is less. Under certain fault conditions, high energy sources could provide substantially more current or power than a module can handle. It is important to provide external current limiting, such as fuses, if the module inputs are connected to high energy sources.

CAUTION

Install current limiting devices between high energy sources and the module inputs.

Electrical Operating Conditions

This module is designed to operate in a temperature range of 0 °C to +55 °C with non-condensing humidity. The maximum humidity is 95% at 40 °C. Do not use in locations where conductive dust or electrolytic salt dust may be present.

These modules should be operated in an indoor environment where temperature and humidity are controlled. Condensation can pose a potential shock hazard. Condensation can occur when the modules are moved from a cold to a warm environment, or if the temperature and/or humidity of the environment changes quickly.

Refer to the data sheet for maximum voltage, current, and power dissipation ratings for each module. For the latest specifications, check the Keysight web site at: www.keysight.com/find/pxi-dio.



电缆 Cables		有毒有害物质或元素 Toxic or Hazardous Substances and Elements					
部件名称 Part Name		铅 Pb	汞 Hg	镉 Cd	六价铬 CrVI	多溴联苯 PBB	多溴二苯醚 PBDE
接口电缆	Interface Cables	×	○	○	×	○	○
电缆附件	Cable accessories	×	○	○	×	○	○
半刚性电缆	Semi Rigid Cables	×	○	○	○	○	○
电源线	Power cords	×	○	○	○	○	○

O: 表示该有毒有害物质在该部件所有均质材料中的含量均在 SJ/T11363-2006 标准规定的限量要求以下。

X: 表示该有毒有害物质至少在该部件某一均质材料中的含量超出SJ/T11363-2006 标准规定的限量要求。

O: Indicates that this toxic or hazardous substance contained in all of the homogeneous materials for this part is below the limit requirement in SJ/T11363-2006.

X: Indicates that this toxic or hazardous substance contained in at least one of the homogeneous materials used for this part is above the limit requirement in SJ/T11363-2006.

如果上述表单多于一个，请参考您的订单或者装箱单从上述表格中找到适合您的产品的列表。

If more than one table is shown above, reference your order or packing list to determine which is applicable to your product.

若您需要了解有关本产品的生产日期信息，请联系您的安捷伦销售代表。

If you have a question about the manufacturing date for your product, ask your Agilent representative

有关如何与安捷伦联系的信息，请参考产品使用手册。

For Agilent contact information, please reference your product manual.

根据中国《电子信息产品污染控制管理办法》的规定，安捷伦已经为本产品标识了显示其环保使用期限的数字。该数字是对本产品在使用和正常操作条件下的使用寿命的评估，其使用和操作条件已经在产品使用手册上做出了明确的规定和说明。该数字仅为与《管理办法》为目的的活动提供参考，并不意味着并担保本产品环保使用期限过期前免于损坏。该环保使用期限不代表任何担保或保证。该环保使用期限数字不改变任何创立的担保，并且不影响与该产品销售相关的任何方面、任何项目及条件。您使用的安捷伦产品可能包含一些可替换的零部件（包括驱动器、电源、鼠标、显示器或者电池等非安捷伦制造的产品），他们的环保使用期限比安捷伦产品本身的环保使用期限短。对于这些非安捷伦制造的零部件标识其环保使用期限数字，其本身标的EPUP有高的优先权，安捷伦对非安捷伦制造的产品环保使用期限没有任何主张也不负任何责任。

In accordance with the requirements of China's Administrative Measure on the Control of Pollution Caused by Electronic Information Products (the "Measure"), Agilent has labeled this product with a number identifying its Environment-Protection Use Period ("EPUP") This number reflects an estimate of the expected life of the product under the normal use and operating conditions as defined in the product user manual which is distributed with the product. Use of the number is only for purposes related to the Measure and does not imply or guarantee that the product is free from defects prior to the EPUP expiration date. No warranties or guarantees are implied by use of the EPUP number. Use of the EPUP number does not alter any warranties found in, nor affect in any way, the terms and conditions associated with the purchase of this product.

Your Agilent product may contain replaceable assemblies/components (including disk drive, power supply, mouse, display, or battery, which are not manufactured by Agilent) which have a shorter EPUP number than that which is indicated on the product itself. In cases where the assembly, component, or part is labeled with an EPUP which differs from the one indicated by Agilent, the EPUP on the assemblies/component or part takes precedence. Agilent makes no claims concerning, and takes no responsibility for the EPUP numbers reflected on goods which are not manufactured by Agilent.

myKeysight

MyKeysight
www.keysight.com/find/mykeysight

A personalized view into the information most relevant to you.



www.axistandard.org
Advanced TCA® Extensions for Instrumentation and Test (AXIe) is an open standard that extends the Advanced TCA for general purpose and semiconductor test. Keysight is a founding member of the AXIe consortium.



www.lxistandard.org
LAN eXtensions for instruments puts the power of Ethernet and the Web inside your test systems. Keysight is a founding member of the LXI consortium.



www.pxisa.org
PCI eXtensions for Instrumentation (PXI) modular instrumentation delivers a rugged PC-based high-performance measurement and automation platform.



www.keysight.com/find/ThreeYearWarranty
Keysight's combination of product reliability and three-year warranty coverage is another way we help you achieve your business goals: increased confidence in uptime, reduced cost of ownership and greater convenience.

Keysight Assurance Plans

Keysight Advantage Services
www.keysight.com/find/AssurancePlans

Five years of protection and no budgetary surprises to ensure your instruments are operating to specifications and you can continually rely on accurate measurements.



www.keysight.com/quality

Keysight Electronic Measurement Group DEKRA Certified ISO 9001:2008 Quality Management System

Keysight Channel Partners

www.keysight.com/find/channelpartners

Get the best of both worlds: Keysight's measurement expertise and product breadth, combined with channel partner convenience.

www.keysight.com
www.keysight.com/find/modular
www.keysight.com/find/pxi-switch

For more information on Keysight Technologies' products, applications or services, please contact your local Keysight office. The complete list is available at: www.keysight.com/find/assist

For other unlisted Countries:
www.keysight.com/find/contactus





This information is subject to change
without notice.
© Keysight Technologies, 2014
Edition 3 December 2014



M9187-90001

www.keysight.com